

MYBOOK COLLECTION

Design
Giò Colonna Romano

Collection
MYBOOK 3X3
MYBOOK 3X4
MYBOOK 4X4
MYBOOK 3X5
MYBOOK 4X5
MYBOOK 5X5



MYBOOK 3x3

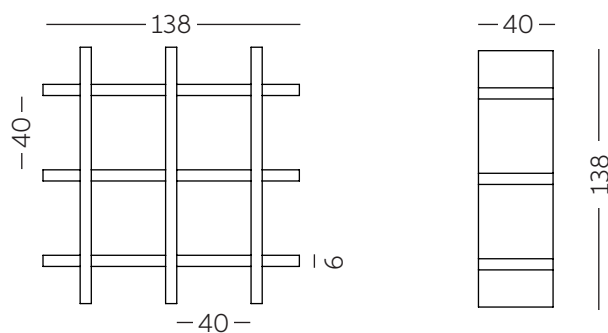

Design
Giò Colonna Romano



PRODUCT	Category: Categoria: Catégorie:	Bookcase Libreria Bibliothèque	PACKAGING	Packaging dimensions: Dimensioni imballaggio: Dimensions emballage:	42 x 32 x 140 cm
	Years of production: Anno di produzione: Année de production:	2008		Packaging volume: Volume Imballaggio: Volume emballage:	0,376 m ³
	Materials: Materiali: Matériaux:	Polyethylene Polietilene Polyéthylène		Total weight: Peso totale: Poids total:	0,376 Kg
	Dimensions: Dimensioni: Dimensions:	138 x 40 h 138 cm		No. of cartons: Nr. di imballi: N°. de cartons:	2
	Weight: Peso: Poids:	36 Kg		Notes: Note: Notes:	

* Dimensions in centimeters

STANDARD

CODE CODICE CODE	SD BOK138	
TECHNICAL INFO INFO TECNICHE INFOS TECHNIQUES		
COLOURS COLORI COULEURS	<p>STANDARD COLOURS</p> 	
NOTES NOTE NOTES		

MYBOOK 3x4



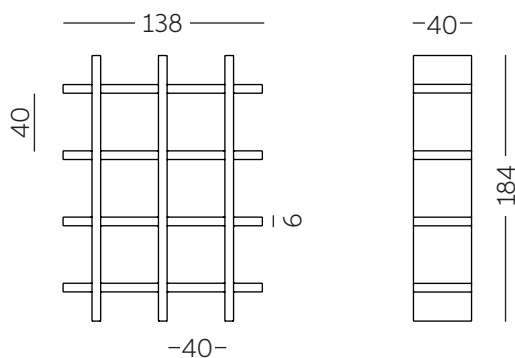





































Design
Giò Colonna Romano



PRODUCT	Category: Categoria: Catégorie:	Bookcase Libreria Bibliothèque	PACKAGING	Packaging dimensions: Dimensioni imballaggio: Dimensions emballage:	42 x 32 x 140 cm 42 x 32 x 186 cm
	Years of production: Anno di produzione: Année de production:	2008		Packaging volume: Volume Imballaggio: Volume emballage:	0,438 m ³
	Materials: Materiali: Matériaux:	Polyethylene Polietilene Polyéthylène		Total weight: Peso totale: Poids total:	56 Kg
	Dimensions: Dimensioni: Dimensions:	138 x 40 h 184 cm		No. of cartons: Nr. di imballi: N°. de cartons:	2
	Weight: Peso: Poids:	48 Kg		Notes: Note: Notes:	

* Dimensions in centimeters

STANDARD

CODE CODICE CODE	SD BKC138																													
TECHNICAL INFO INFO TECNICHE INFOS TECHNIQUES																														
COLOURS COLORI COULEURS	<p>STANDARD COLOURS</p> <table border="0"> <tr> <td></td> <td></td> <td></td> <td></td> <td></td> <td></td> <td></td> </tr> <tr> <td>MILKY WHITE</td> <td>JET BLACK</td> <td>ELEPHANT GREY</td> <td>CHOCOLATE BROWN</td> <td>ARGIL GREY</td> <td>DOVE GREY</td> <td></td> </tr> <tr> <td></td> <td></td> <td></td> <td></td> <td></td> <td></td> <td></td> </tr> <tr> <td>POWDER BLUE</td> <td>MALVA GREEN</td> <td>LIME GREEN</td> <td>SAFFRON YELLOW</td> <td>PUMPKIN ORANGE</td> <td>FLAME RED</td> <td>SWEET FUCHSIA</td> </tr> </table>									MILKY WHITE	JET BLACK	ELEPHANT GREY	CHOCOLATE BROWN	ARGIL GREY	DOVE GREY									POWDER BLUE	MALVA GREEN	LIME GREEN	SAFFRON YELLOW	PUMPKIN ORANGE	FLAME RED	SWEET FUCHSIA
																														
MILKY WHITE	JET BLACK	ELEPHANT GREY	CHOCOLATE BROWN	ARGIL GREY	DOVE GREY																									
																														
POWDER BLUE	MALVA GREEN	LIME GREEN	SAFFRON YELLOW	PUMPKIN ORANGE	FLAME RED	SWEET FUCHSIA																								
NOTES NOTE NOTES																														

MYBOOK 4x4

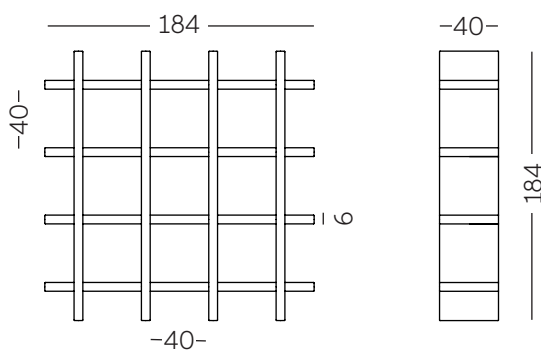
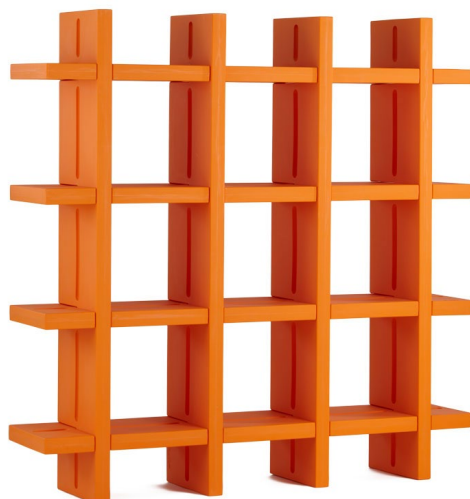

Design
Giò Colonna Romano



PRODUCT	Category: Categoria: Catégorie:	Bookcase Libreria Bibliothèque	PACKAGING	Packaging dimensions: Dimensioni imballaggio: Dimensions emballage:	42 x 32 x 186 cm
	Years of production: Anno di produzione: Année de production:	2008		Packaging volume: Volume Imballaggio: Volume emballage:	0,5 m ³
	Materials: Materiali: Matériaux:	Polyethylene Polietilene Polyéthylène		Total weight: Peso totale: Poids total:	72 Kg
	Dimensions: Dimensioni: Dimensions:	184 x 40 h 184 cm		No. of cartons: Nr. di imballi: N° de cartons:	2
	Weight: Peso: Poids:	64 Kg		Notes: Note: Notes:	

* Dimensions in centimeters

STANDARD

CODE CODICE CODE	SD BKC184	
TECHNICAL INFO INFO TECNICHE INFOS TECHNIQUES		
COLOURS COLORI COULEURS	<p>STANDARD COLOURS</p> 	
NOTES NOTE NOTES		

MYBOOK 3x5



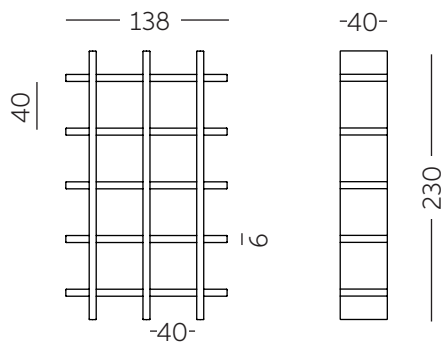
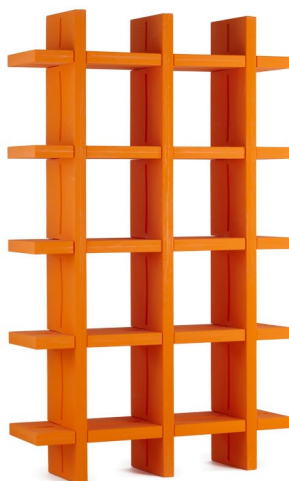





































Design
Giò Colonna Romano



PRODUCT	Category: Categoria: Catégorie:	Bookcase Libreria Bibliothèque	PACKAGING	Packaging dimensions: Dimensioni imballaggio: Dimensions emballage:	42 x 32 x 140 cm 42 x 32 x 232 cm
	Years of production: Anno di produzione: Année de production:	2008		Packaging volume: Volume Imballaggio: Volume emballage:	0,5 m ³
	Materials: Materiali: Matériaux:	Polyethylene Polietilene Polyéthylène		Total weight: Peso totale: Poids total:	68 Kg
	Dimensions: Dimensioni: Dimensions:	138 x 40 h 230 cm		No. of cartons: Nr. di imballi: N°. de cartons:	2
	Weight: Peso: Poids:	60 Kg		Notes: Note: Notes:	

* Dimensions in centimeters

STANDARD

CODE CODICE CODE	SD BOK200																											
TECHNICAL INFO INFO TECNICHE INFOS TECHNIQUES																												
COLOURS COLORI COULEURS	<p>STANDARD COLOURS</p> <table border="0"> <tr> <td></td> <td></td> <td></td> <td></td> <td></td> <td></td> </tr> <tr> <td>MILKY WHITE</td> <td>JET BLACK</td> <td>ELEPHANT GREY</td> <td>CHOCOLATE BROWN</td> <td>ARGIL GREY</td> <td>DOVE GREY</td> </tr> <tr> <td></td> <td></td> <td></td> <td></td> <td></td> <td></td> <td></td> </tr> <tr> <td>POWDER BLUE</td> <td>MALVA GREEN</td> <td>LIME GREEN</td> <td>SAFFRON YELLOW</td> <td>PUMPKIN ORANGE</td> <td>FLAME RED</td> <td>SWEET FUCHSIA</td> </tr> </table>								MILKY WHITE	JET BLACK	ELEPHANT GREY	CHOCOLATE BROWN	ARGIL GREY	DOVE GREY								POWDER BLUE	MALVA GREEN	LIME GREEN	SAFFRON YELLOW	PUMPKIN ORANGE	FLAME RED	SWEET FUCHSIA
																												
MILKY WHITE	JET BLACK	ELEPHANT GREY	CHOCOLATE BROWN	ARGIL GREY	DOVE GREY																							
																												
POWDER BLUE	MALVA GREEN	LIME GREEN	SAFFRON YELLOW	PUMPKIN ORANGE	FLAME RED	SWEET FUCHSIA																						
NOTES NOTE NOTES																												

MYBOOK 4x5



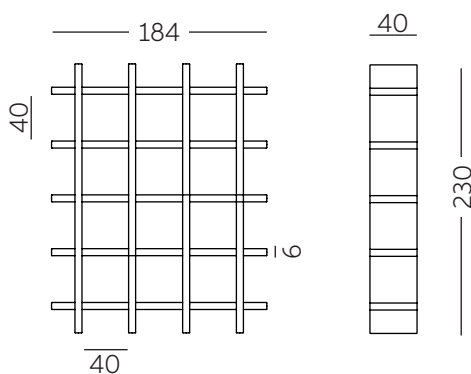
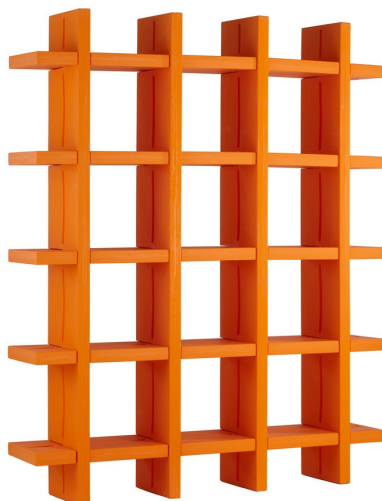





































Design
Giò Colonna Romano



PRODUCT	Category: Categoria: Catégorie:	Bookcase Libreria Bibliothèque	PACKAGING	Packaging dimensions: Dimensioni imballaggio: Dimensions emballage:	42 x 32 x 186 cm 42 x 32 x 232 cm
	Years of production: Anno di produzione: Année de production:	2008		Packaging volume: Volume Imballaggio: Volume emballage:	0,562 m ³
	Materials: Materiali: Matériaux:	Polyethylene Polietilene Polyéthylène		Total weight: Peso totale: Poids total:	88 Kg
	Dimensions: Dimensioni: Dimensions:	184 x 40 h 230 cm		No. of cartons: Nr. di imballi: N°. de cartons:	2
	Weight: Peso: Poids:	80 Kg		Notes: Note: Notes:	

* Dimensions in centimeters

STANDARD

CODE CODICE CODE	SD BKC230																											
TECHNICAL INFO INFO TECNICHE INFOS TECHNIQUES																												
COLOURS COLORI COULEURS	<p>STANDARD COLOURS</p> <table border="0"> <tr> <td></td> <td></td> <td></td> <td></td> <td></td> <td></td> </tr> <tr> <td>MILKY WHITE</td> <td>JET BLACK</td> <td>ELEPHANT GREY</td> <td>CHOCOLATE BROWN</td> <td>ARGIL GREY</td> <td>DOVE GREY</td> </tr> <tr> <td></td> <td></td> <td></td> <td></td> <td></td> <td></td> <td></td> </tr> <tr> <td>POWDER BLUE</td> <td>MALVA GREEN</td> <td>LIME GREEN</td> <td>SAFFRON YELLOW</td> <td>PUMPKIN ORANGE</td> <td>FLAME RED</td> <td>SWEET FUCHSIA</td> </tr> </table>								MILKY WHITE	JET BLACK	ELEPHANT GREY	CHOCOLATE BROWN	ARGIL GREY	DOVE GREY								POWDER BLUE	MALVA GREEN	LIME GREEN	SAFFRON YELLOW	PUMPKIN ORANGE	FLAME RED	SWEET FUCHSIA
																												
MILKY WHITE	JET BLACK	ELEPHANT GREY	CHOCOLATE BROWN	ARGIL GREY	DOVE GREY																							
																												
POWDER BLUE	MALVA GREEN	LIME GREEN	SAFFRON YELLOW	PUMPKIN ORANGE	FLAME RED	SWEET FUCHSIA																						
NOTES NOTE NOTES																												

MYBOOK 5x5



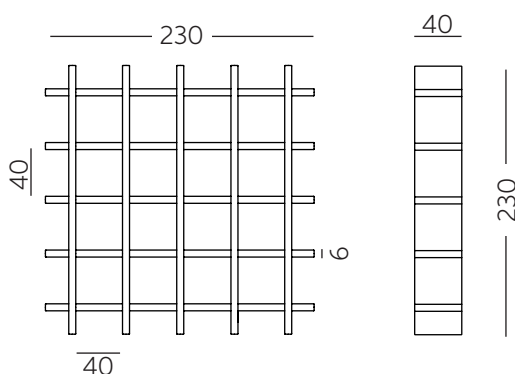





































Design
Giò Colonna Romano



PRODUCT	Category: Categoria: Catégorie:	Bookcase Libreria Bibliothèque	PACKAGING	Packaging dimensions: Dimensioni imballaggio: Dimensions emballage:	42 x 32 x 232 cm
	Years of production: Anno di produzione: Année de production:	2008		Packaging volume: Volume Imballaggio: Volume emballage:	0,624 m ³
	Materials: Materiali: Matériaux:	Polyethylene Polietilene Polyéthylène		Total weight: Peso totale: Poids total:	108 Kg
	Dimensions: Dimensioni: Dimensions:	230 x 40 h 230 cm		No. of cartons: Nr. di imballi: N° de cartons:	2
	Weight: Peso: Poids:	100 Kg		Notes: Note: Notes:	

* Dimensions in centimeters

STANDARD



CODE CODICE CODE	SD BOC230																											
TECHNICAL INFO INFO TECNICHE INFOS TECHNIQUES																												
COLOURS COLORI COULEURS	<p>STANDARD COLOURS</p> <table border="0"> <tr> <td></td> <td></td> <td></td> <td></td> <td></td> <td></td> </tr> <tr> <td>MILKY WHITE</td> <td>JET BLACK</td> <td>ELEPHANT GREY</td> <td>CHOCOLATE BROWN</td> <td>ARGIL GREY</td> <td>DOVE GREY</td> </tr> <tr> <td></td> <td></td> <td></td> <td></td> <td></td> <td></td> <td></td> </tr> <tr> <td>POWDER BLUE</td> <td>MALVA GREEN</td> <td>LIME GREEN</td> <td>SAFFRON YELLOW</td> <td>PUMPKIN ORANGE</td> <td>FLAME RED</td> <td>SWEET FUCHSIA</td> </tr> </table>								MILKY WHITE	JET BLACK	ELEPHANT GREY	CHOCOLATE BROWN	ARGIL GREY	DOVE GREY								POWDER BLUE	MALVA GREEN	LIME GREEN	SAFFRON YELLOW	PUMPKIN ORANGE	FLAME RED	SWEET FUCHSIA
																												
MILKY WHITE	JET BLACK	ELEPHANT GREY	CHOCOLATE BROWN	ARGIL GREY	DOVE GREY																							
																												
POWDER BLUE	MALVA GREEN	LIME GREEN	SAFFRON YELLOW	PUMPKIN ORANGE	FLAME RED	SWEET FUCHSIA																						
NOTES NOTE NOTES																												

ACCESSORIES / ACCESSORI / ACCESSOIRES

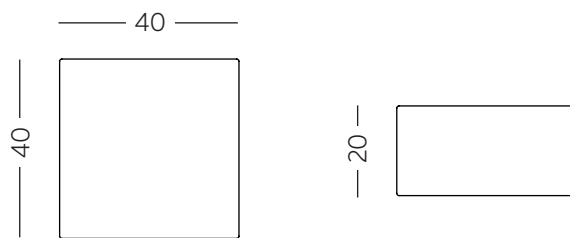



QUADRO / QUADRO / QUADRO























LIGHTING / LUMINOSO / LUMINEUSE

CODE CODICE CODE	SD QUO040			
TECHNICAL INFO INFO TECNICHE INFOS TECHNIQUES	Lighting system: Sistema di illuminazione: Système d'éclairage:	Bulb Lampadina Ampoule	1 x 10W - A65 / E27	Not included Non incluso Non inclus
	Wiring: Cablaggio: Câblage:	Transparent cable + inline cord switch on/off Cavo trasparente + interruttore passafilo on/off Câble transparent + interrupteur de passage on/off		Length: 1,5 m Lunghezza: 1,5 m Longueur: 1,5 m
	Entrance dimensions: Dimensioni ingresso: Dimensions de l'entrée:	Ø 76 mm	Accessory on request: Accessorio su richiesta: Accessoire sur demande:	
COLOURS COLORI COULEURS	LIGHTING COLOURS			
	 LIGHT WHITE			
NOTES NOTE NOTES				
TECHNICAL INFO INFO TECNICHE INFOS TECHNIQUES	Material: Materiale: Matériel:	Polyethylene Polietilene Polyéthylène		
COLOURS COLORI COULEURS	Dimensions: Dimensioni: Dimensions:	40 x 20 h 40 cm	Weight: Peso: Poids:	3 Kg
PACKAGING IMBALLO EMBALLAGE	Dimensions: Dimensioni: Dimensions:	41 x 41 x 24 cm	Weight: Peso: Poids:	4 Kg
	Packaging volume: Volume Imballaggio: Volume emballage:	0,04 m ³	No. of cartons: Nr. di imballi: N°. de cartons:	1
NOTES NOTE NOTES				

SYMBOLS

	Product for indoor use only. Prodotto per uso interno. Produit à usage interne.		
	Product for indoor and outdoor use. Prodotto per uso interno ed esterno. Produit à usage interne et externe.		Product version for outdoor on request. Versione prodotto per uso esterno su richiesta. Version du produit pour extérieur sur demande.
	Fireproof product. Prodotto ignifugo. Produit ignifuge.		Product with soft seat. Prodotto con seduta morbida. Produit avec assise souple.
	Stackable product. Prodotto impilabile. Produit empilable.		Product with special packaging. Prodotto con scatola speciale. Produit avec carton spécial.
	Conformity to the European Community instructions. Conformità alle istruzioni della Comunità Europea. Conformité aux instructions de la Communauté Européenne.		Product made with 100% recyclable material. Prodotto realizzato in materiale riciclabile al 100%. Produit réalisé avec matériau 100% recyclable.

LIGHTING SYMBOLS

	Lighting system compatible with LED light bulbs. Sistema di illuminazione compatibile con lampadine LED. Système d'éclairage compatible avec des ampoules LED.		
	LED lighting system. Sistema di illuminazione a LED. Système d'éclairage LED.		RGB LED multicolour system. Sistema LED RGB multicolore. Système LED RGB multicolore.
	LED tube lighting system. Sistema di illuminazione per tubo LED. Système d'éclairage pour tube LED.		3W battery RGBW LED system included. Kit 3W LED RGBW a batteria inclusa. Kit de batteries LED 3W RGBW inclus.
	Product compatible with Candy Light module. Prodotto compatibile con modulo Candy Light. Produit compatible avec le module Candy Light.		Product compatible with Candy Light XL module. Prodotto compatibile con modulo Candy Light XL. Produit compatible avec le module Candy Light XL.
	Dimmable item. Prodotto dimmerabile. Article dimmable.		
	Product with base model I1. Prodotto con base I1. Produit avec base I1.		Product with base model E1. Prodotto con base E1. Produit avec base E1.
	Product with base model I3. Prodotto con base I3. Produit avec base I3.		Product with base model E3. Prodotto con base E3. Produit avec base E3.
	Protected against the intrusion of solid objects $\varnothing > 12$ mm, not against water. Protetto contro l'intrusione di corpi solidi $\varnothing > 12$ mm, non contro l'acqua. Protégé contre l'intrusion de corps solides $\varnothing > 12$ mm, pas contre l'eau.		
	Protected against the intrusion of dust and water jets. Protetto contro l'intrusione di polvere e getti d'acqua. Protégé contre l'intrusion de poussières et de jets d'eau.		
	Fully protected against the intrusion of dust and immersion in water. Completamente protetto contro l'intrusione di polvere e l'immersione in acqua. Entièrement protégé contre l'intrusion de poussière et l'immersion dans l'eau.		
	Insulation class 1. Classe di isolamento 1. Classe d'isolation 1.		
	Insulation class 2. Classe di isolamento 2. Classe d'isolation 2.		
	Insulation class 3. Classe di isolamento 3. Classe d'isolation 3.		
	Device proper to direct assembly onto normally inflammable surfaces. Dispositivo adatto al montaggio diretto su superfici normalmente infiammabili. Dispositif adapté à un montage direct sur des surfaces normalement inflammables.		
	On request, the photometric data of the product are available in EULUMDAT standard or a similar one. Su richiesta, sono disponibili i dati fotometrici del prodotto nello standard EULUMDAT o similari. Sur demande, les données photométriques du produit dans la norme EULUMDAT ou similaire sont disponibles.		



EN - Warning: the appropriate use of these instructions ensures the good maintenance of the product. Always consult the technical sheet of the product on the www.slidedesign.it website.

- Before any operation on the fixture, please disconnect the power supply.
- Assembly and maintenance of the fixture must be performed carefully so components are not damaged.
- Replacement bulbs must be the same type and wattage as specified in the technical sheet. Use LED bulbs only.
- In case of damage to the feeding cable, please contact a SLIDE dealer or qualified personnel for replacement.
- Keep away from excessive heat sources.
- Avoid any improper use. Do not stand on the products. When the product has to be moved, lift the product off the ground in order to avoid damages.
- Always protect the product with its original packaging when not in use for a long time.



IT - Attenzione: l'uso appropriato delle seguenti istruzioni garantisce il buon mantenimento del prodotto, pertanto è necessario conservarle. Consultare la scheda tecnica del prodotto sul sito www.slidedesign.it.

- Prima di ogni operazione sull'apparecchio, disinserire la tensione di rete.
- Le operazioni di montaggio o manutenzione devono essere eseguite con la massima attenzione per non danneggiare i componenti.
- L'eventuale sostituzione della lampadina deve essere fatta con una dello stesso tipo e potenza massima indicata nella scheda tecnica. Si raccomanda l'uso esclusivo di lampadine a basso consumo energetico.
- In caso di danneggiamento del cavo di alimentazione, per la sostituzione contattare un rivenditore SLIDE o personale qualificato.
- Evitare di posizionare il prodotto in prossimità di fonti di calore eccessive.
- Evitare usi impropri e non consoni del prodotto. Non salire con i piedi sul prodotto. In caso di spostamento, sollevare il prodotto onde evitare danni ai componenti che appoggiano a terra.
- Proteggere sempre il prodotto con il suo imballo originale quando inutilizzato per lungo tempo.



FR - Attention: l'entretien correct du produit est garanti par l'application appropriée de ces instructions. Il est donc nécessaire de les garder. Toujours consulter la fiche technique du produit sur le site www.slidedesign.it.

- Avant toute opération sur l'appareil déconnecter l'alimentation électrique.
- Le montage et les manipulations de l'appareil devront être exécutés avec la plus grande attention pour ne pas abîmer ses composants.
- Tout changement d'ampoule respectera le type et la puissance indiqués dans la fiche technique. Il est recommandé de n'utiliser que des ampoules à basse consommation d'énergie.
- En cas d'endommagement du câble d'alimentation, et en vue de son remplacement, contactez votre revendeur SLIDE ou une personne dûment habilitée.
- Éviter de placer le produit à proximité de sources de chaleur excessive.
- Éviter l'utilisation inappropriée du produit. Ne pas monter sur les produits. Lorsque le produit doit être déplacé, soulever le produit afin d'éviter tout dommage.
- Toujours protéger le produit avec son emballage d'origine lorsqu'il n'est pas utilisé.

WARRANTY | GARANZIA | GARANTIE

EN - SLIDE products are guaranteed against all manufacturing faults, granted that the items are appropriately used, for twenty-four (24) months from the date of purchase upon presentation of the invoice.

LEDs are guaranteed for twelve (12) months from the date of purchase.

Warranty doesn't include parts that are subject to wear and tear due to usage, batteries when provided, wiring and electrical parts that do not have manufacturing faults.

SLIDE declines any liability to damages caused to things or persons by an illegitimate use of the product.

SLIDE won't accept any returned goods without having checked the kind of defects first.

IT - I prodotti SLIDE sono garantiti per difetti di fabbricazione in condizioni normali d'uso del prodotto, per un periodo di ventiquattro (24) mesi dalla data di acquisto, comprovata da documento d'acquisto.

Per i sistemi di illuminazione LED la garanzia è di dodici (12) mesi dalla data di acquisto.

Sono escluse dalla garanzia le parti soggette ad usura in seguito all'utilizzo, le batterie quando fornite in dotazione, cavi e componenti elettrici, che non presentino difetti di fabbricazione.

SLIDE declina ogni responsabilità per danni causati a cose o persone da un uso non corretto del prodotto.

SLIDE non accetterà nessun reso se non dopo aver accertato la natura del difetto.

FR - Les produits SLIDE sont garantis contre les vices de fabrication dans des conditions d'utilisation normales, pour une période de vingt-quatre (24) mois à compter de la date d'achat, avec la preuve d'achat.

Pour les systèmes d'éclairage LED la garantie est de douze (12) mois à compter de la date d'achat.

La garantie ne couvre pas les pièces d'usure après utilisation, les piles si fournis, et câbles et composants électriques qui n'ont pas de défauts de fabrication.

SLIDE décline toute responsabilité pour les dommages causés aux personnes ou aux biens dus à une utilisation inappropriée du produit. SLIDE ne remplacera aucun appareil sans avoir pu en constater le défaut.

MAINTENANCE & CLEANING | MANUTENZIONE & PULIZIA | MAINTENANCE & NETTOYAGE

EN - Check the material composition of the product on the technical sheet on www.slidedesign.it.

- To prevent dust and dirt from sticking to the plastic surfaces, periodically clean the products.
- Avoid using ethanol or any liquids containing acetone, trichloroethylene or ammonia (solvents in general).
- **POLYETHYLENE:** clean the product with a damp cloth and neutral liquid soap diluted in water.
It is recommended the use of SLIDE's "CleanUp" cleaner or a degreaser. In case of persistent stains, use a scrub eraser (melamine foam - Scotch-Brite Easy Eraser or similar) or a hot water pressure washer.
Spray the cleaning product on the surface, rub with a damp cloth and rinse abundantly with hot water.
- **POLYURETHANE:** clean the products with a soft cloth and neutral liquid soap diluted in water, especially if the surface comes into contact with highly coloured substances (such as coffee, tea, oil, etc.).
- **POLYPROPYLENE:** clean the products with a damp cloth and neutral liquid soap diluted in water and degreaser.
Rinse with plenty of water.
- Lacquered version: periodically clean with a polish cleaner, gently rubbing with soft cloth/cotton wool.
- Fabrics can be cleaned with a damp cloth, neutral liquid soap and water.
- For metal parts use specific cleaners.
- For **HPL**, clean the surface with a damp cloth and neutral liquid soap diluted in water.

IT - Verificare il materiale di composizione del prodotto sulla scheda tecnica sul sito www.slidedesign.it.

- Evitare accumuli di polvere o di sporco sulle superfici e pulire periodicamente il prodotto.
- Evitare l'uso di alcool e di detersivi contenenti acetone, trielina e ammoniaca (solventi in generale).
- **POLIETILENE:** pulire il prodotto con un panno umido e detersivo liquido neutro, diluito con acqua.
È consigliato l'utilizzo del pulitore "CleanUp" di SLIDE o di uno sgrassatore e, in caso di macchie persistenti, l'utilizzo di gomma cancella-macchie (schiuma di melamina: Scotch-Brite o simili) o idropulitrice ad acqua calda. Spruzzare lo sgrassatore sulla superficie da trattare e strofinare con un panno umido.
Risciacquare abbondantemente con acqua, preferibilmente con idropulitrice ad acqua calda.
- **POLIURETANO:** pulire il prodotto con un panno morbido, frizionando, soprattutto nel caso la superficie venga a contatto con sostanze particolarmente coloranti (es. caffè, tè, olio, ecc). Utilizzare solo prodotti neutri in soluzione acquosa.
- **POLIPROPILENE:** pulire con un panno umido e acqua con detersivo sgrassante. Risciacquare abbondantemente con acqua.
- Per la versione laccata: pulire periodicamente con una pasta tipo "polish" o cera auto, strofinando delicatamente con ovatta.
- Per la pulizia dei tessuti utilizzare un panno umido con sapone neutro e acqua.
- Per le parti metalliche utilizzare prodotti specifici evitando l'uso di polveri abrasive e pagliette.
- Per l'**HPL**, pulire il prodotto con un panno umido e detersivo liquido neutro, diluito con acqua.

FR - Vérifier la composition des matériaux du produit sur la fiche technique sur www.slidedesign.it.

- Eviter l'accumulation de poussière et de saleté sur la surface et nettoyer régulièrement le produit.
- Eviter d'utiliser alcool et détergents contenant de l'acétone, du trichloréthylène et de l'ammoniac (solvants en général).
- **POLYETHYLENE:** nettoyer le produit avec un chiffon humide et un détergent liquide neutre dilué avec de l'eau.
Il est recommandé d'utiliser le détergent "CleanUp" de SLIDE ou un dégraissant et, en cas de taches persistantes, d'utiliser une éponge grattante (mousse de mélamine: Scotch-Brite ou similaire) ou nettoyeur haute pression d'eau chaude.
Vaporiser le produit sur la surface, frotter avec un chiffon humide et rincer abondamment avec de l'eau.
- **POLYURETHANE:** nettoyer le produit avec un chiffon, en frottant, surtout si la surface est entrée en contact avec des substances particulièrement colorantes. N'utiliser que des produits neutres en solution aqueuse.
- **POLYPROPYLENE:** nettoyer avec un chiffon humide et de l'eau avec un détergent dégraissant.
Rincer abondamment avec de l'eau.
- Version laquée: utiliser périodiquement une pâte de type "polish" ou de la cire, en frottant doucement avec un chiffon.
- Pour nettoyer les tissus utiliser un chiffon humide avec un savon doux et de l'eau.
- Pour les parties métalliques, utiliser des produits spécifiques.
- Pour l'**HPL**, nettoyer la surface avec un chiffon humide et un détergent liquide neutre dilué avec de l'eau.



Product made with 100% recyclable material.
Prodotto in materiale riciclabile al 100%.
Produit réalisé en matériel 100% recyclable.



Certifies the conformity of the product to the European Community instructions.
Certifica la conformità del prodotto alle disposizioni delle direttive comunitarie.
Atteste la conformité du produit aux dispositions des directives communautaires.



Appliance suitable for installation on normally inflammable surfaces.
Apparecchio idoneo ad essere installato su superfici normalmente infiammabili.
L'appareil peut être installé sur des surfaces normalement inflammables.



Recycling and disposal of electronic waste (WEEE).
Questo prodotto richiede uno smaltimento differenziato (RAEE).
Ce produit nécessite un tri sélectif (DEEE).

ASSEMBLY INSTRUCTIONS

ISTRUZIONI DI MONTAGGIO
INSTRUCTIONS DE MONTAGE



I1

BASE MODEL



Certifies the conformity of the product to the European Community instructions.
Certifica la conformità del prodotto alle disposizioni delle direttive comunitarie.
Atteste la conformité du produit aux dispositions des directives communautaires.



Appliance suitable for installation on normally inflammable surfaces.
Apparecchio idoneo ad essere installato su superfici normalmente infiammabili.
L'appareil peut être installé sur des surfaces normalement inflammables.



Class 2: appliance fitted with double insulation, without ground connection.
Classe 2: apparecchio con doppio isolamento, non richiede messa a terra.
Classe 2: appareil à double isolation, ne nécessite pas de mise à la terre.



Appliance for indoor use only.
Apparecchio per solo uso interno.
Appareil pour usage interne uniquement.

MADE IN ITALY

Consult the technical sheet for this product on:
Consultare la scheda tecnica di questo prodotto su:
Consulter la fiche technique de ce produit sur:

www.slidedesign.it

BULB REPLACEMENT

1

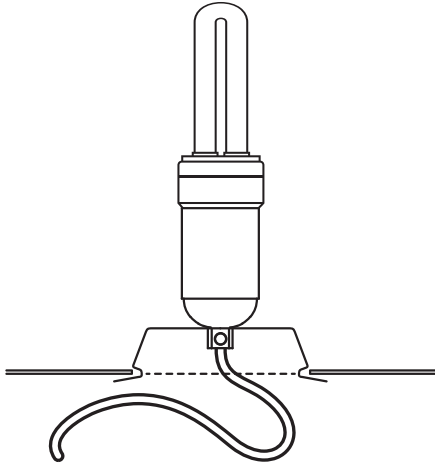

2

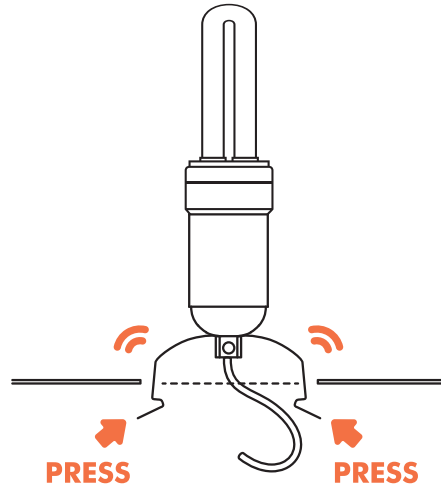

3

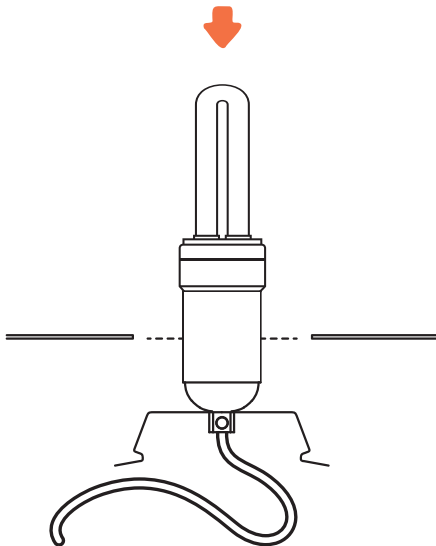



EN - Warning: the appropriate use of these instructions ensures the good maintenance of the product.

Always consult the technical sheet of the product on the www.slidedesign.it website.

- Before any operation on the fixture, please disconnect the power supply.
- Assembly and maintenance of the fixture must be performed carefully so components are not damaged.
- Replacement bulbs must be the same type and wattage as specified in the technical sheet.
Use LED bulbs only.
- In case of damage to the feeding cable, please contact a SLIDE dealer or qualified personnel for replacement.
- Keep away from excessive heat sources.
- Avoid any improper use. Do not stand on the products. When the product has to be moved, lift the product off the ground in order to avoid damages.
- Always protect the product with its original packaging when not in use for a long time.



IT - Attenzione: l'uso appropriato delle seguenti istruzioni garantisce il buon mantenimento del prodotto, pertanto è necessario conservarle. Consultare la scheda tecnica del prodotto sul sito www.slidedesign.it.

- Prima di ogni operazione sull'apparecchio, disinserire la tensione di rete.
- Le operazioni di montaggio o manutenzione devono essere eseguite con la massima attenzione per non danneggiare i componenti.
- L'eventuale sostituzione della lampadina deve essere fatta con una dello stesso tipo e potenza massima indicata nella scheda tecnica. Si raccomanda l'uso esclusivo di lampadine a basso consumo energetico.
- In caso di danneggiamento del cavo di alimentazione, per la sostituzione contattare un rivenditore SLIDE o personale qualificato.
- Evitare di posizionare il prodotto in prossimità di fonti di calore eccessive.
- Evitare usi impropri e non consoni del prodotto. Non salire con i piedi sul prodotto. In caso di spostamento, sollevare il prodotto onde evitare danni ai componenti che appoggiano a terra.
- Proteggere sempre il prodotto con il suo imballo originale quando inutilizzato per lungo tempo.



FR - Attention: l'entretien correct du produit est garanti par l'application appropriée de ces instructions. Il est donc nécessaire de les garder. Toujours consulter la fiche technique du produit sur le site www.slidedesign.it.

- Avant toute opération sur l'appareil déconnecter l'alimentation électrique.
- Le montage et les manipulations de l'appareil devront être exécutés avec la plus grande attention pour ne pas abîmer ses composants.
- Tout changement d'ampoule respectera le type et la puissance indiqués dans la fiche technique. Il est recommandé de n'utiliser que des ampoules à basse consommation d'énergie.
- En cas d'endommagement du câble d'alimentation, et en vue de son remplacement, contactez votre revendeur SLIDE ou une personne dûment habilitée.
- Éviter de placer le produit à proximité de sources de chaleur excessive.
- Éviter l'utilisation inappropriée du produit. Ne pas monter sur les produits. Lorsque le produit doit être déplacé, soulever le produit afin d'éviter tout dommage.
- Toujours protéger le produit avec son emballage d'origine lorsqu'il n'est pas utilisé.

WARRANTY | GARANZIA | GARANTIE

EN - SLIDE products are guaranteed against all manufacturing faults, granted that the items are appropriately used, for twenty-four (24) months from the date of purchase upon presentation of the invoice.

LEDs are guaranteed for twelve (12) months from the date of purchase.

Warranty doesn't include parts that are subject to wear and tear due to usage, batteries when provided, wiring and electrical parts that do not have manufacturing faults.

SLIDE declines any liability to damages caused to things or persons by an illegitimate use of the product.

SLIDE won't accept any returned goods without having checked the kind of defects first.

IT - I prodotti SLIDE sono garantiti per difetti di fabbricazione in condizioni normali d'uso del prodotto, per un periodo di ventiquattro (24) mesi dalla data di acquisto, comprovata da documento d'acquisto.

Per i sistemi di illuminazione LED la garanzia è di dodici (12) mesi dalla data di acquisto.

Sono escluse dalla garanzia le parti soggette ad usura in seguito all'utilizzo, le batterie quando fornite in dotazione, cavi e componenti elettrici, che non presentino difetti di fabbricazione.

SLIDE declina ogni responsabilità per danni causati a cose o persone da un uso non corretto del prodotto.

SLIDE non accetterà nessun reso se non dopo aver accertato la natura del difetto.

FR - Les produits SLIDE sont garantis contre les vices de fabrication dans des conditions d'utilisation normales, pour une période de vingt-quatre (24) mois à compter de la date d'achat, avec la preuve d'achat.

Pour les systèmes d'éclairage LED la garantie est de douze (12) mois à compter de la date d'achat.

La garantie ne couvre pas les pièces d'usure après utilisation, les piles si fournies, et câbles et composants électriques qui n'ont pas de défauts de fabrication.

SLIDE décline toute responsabilité pour les dommages causés aux personnes ou aux biens dus à une utilisation inappropriée du produit. SLIDE ne remplacera aucun appareil sans avoir pu en constater le défaut.

MAINTENANCE & CLEANING | MANUTENZIONE & PULIZIA | MAINTENANCE & NETTOYAGE

EN - Check the material composition of the product on the technical sheet on www.slidedesign.it.

- To prevent dust and dirt from sticking to the plastic surfaces, periodically clean the products.
- Avoid using ethanol or any liquids containing acetone, trichloroethylene or ammonia (solvents in general).
- **POLYETHYLENE:** clean the product with a damp cloth and neutral liquid soap diluted in water.
It is recommended the use of SLIDE's "CleanUp" cleaner or a degreaser. In case of persistent stains, use a scrub eraser (melamine foam - Scotch-Brite Easy Eraser or similar) or a hot water pressure washer.
Spray the cleaning product on the surface, rub with a damp cloth and rinse abundantly with hot water.
- **POLYURETHANE:** clean the products with a soft cloth and neutral liquid soap diluted in water, especially if the surface comes into contact with highly coloured substances (such as coffee, tea, oil, etc.).
- **POLYPROPYLENE:** clean the products with a damp cloth and neutral liquid soap diluted in water and degreaser.
Rinse with plenty of water.
- Lacquered version: periodically clean with a polish cleaner, gently rubbing with soft cloth/cotton wool.
- Fabrics can be cleaned with a damp cloth, neutral liquid soap and water.
- For metal parts use specific cleaners.
- For **HPL**, clean the surface with a damp cloth and neutral liquid soap diluted in water.

IT - Verificare il materiale di composizione del prodotto sulla scheda tecnica sul sito www.slidedesign.it.

- Evitare accumuli di polvere o di sporco sulle superfici e pulire periodicamente il prodotto.
- Evitare l'uso di alcool e di detersivi contenenti acetone, trielina e ammoniaca (solventi in generale).
- **POLIETILENE:** pulire il prodotto con un panno umido e detersivo liquido neutro, diluito con acqua.
È consigliato l'utilizzo del pulitore "CleanUp" di SLIDE o di uno sgrassatore e, in caso di macchie persistenti, l'utilizzo di gomma cancella-macchie (schiuma di melamina: Scotch-Brite o simili) o idropulitrice ad acqua calda. Spruzzare lo sgrassatore sulla superficie da trattare e strofinare con un panno umido.
Risciacquare abbondantemente con acqua, preferibilmente con idropulitrice ad acqua calda.
- **POLIURETANO:** pulire il prodotto con un panno morbido, frizionando, soprattutto nel caso la superficie venga a contatto con sostanze particolarmente coloranti (es. caffè, tè, olio, ecc). Utilizzare solo prodotti neutri in soluzione acquosa.
- **POLIPROPILENE:** pulire con un panno umido e acqua con detersivo sgrassante. Risciacquare abbondantemente con acqua.
- Per la versione laccata: pulire periodicamente con una pasta tipo "polish" o cera auto, strofinando delicatamente con ovatta.
- Per la pulizia dei tessuti utilizzare un panno umido con sapone neutro e acqua.
- Per le parti metalliche utilizzare prodotti specifici evitando l'uso di polveri abrasive e pagliette.
- Per l'**HPL**, pulire il prodotto con un panno umido e detersivo liquido neutro, diluito con acqua.

FR - Vérifier la composition des matériaux du produit sur la fiche technique sur www.slidedesign.it.

- Eviter l'accumulation de poussière et de saleté sur la surface et nettoyer régulièrement le produit.
- Eviter d'utiliser alcool et détergents contenant de l'acétone, du trichloréthylène et de l'ammoniac (solvants en général).
- **POLYETHYLENE:** nettoyer le produit avec un chiffon humide et un détergent liquide neutre dilué avec de l'eau.
Il est recommandé d'utiliser le détergent "CleanUp" de SLIDE ou un dégraissant et, en cas de taches persistantes, d'utiliser une éponge grattante (mousse de mélamine: Scotch-Brite ou similaire) ou nettoyeur haute pression d'eau chaude.
Vaporiser le produit sur la surface, frotter avec un chiffon humide et rincer abondamment avec de l'eau.
- **POLYURETHANE:** nettoyer le produit avec un chiffon, en frottant, surtout si la surface est entrée en contact avec des substances particulièrement colorantes. N'utiliser que des produits neutres en solution aqueuse.
- **POLYPROPYLENE:** nettoyer avec un chiffon humide et de l'eau avec un détergent dégraissant.
Rincer abondamment avec de l'eau.
- Version laquée: utiliser périodiquement une pâte de type "polish" ou de la cire, en frottant doucement avec un chiffon.
- Pour nettoyer les tissus utiliser un chiffon humide avec un savon doux et de l'eau.
- Pour les parties métalliques, utiliser des produits spécifiques.
- Pour l'**HPL**, nettoyer la surface avec un chiffon humide et un détergent liquide neutre dilué avec de l'eau.



Refer to the instruction before use.
Consultare le istruzioni prima dell'uso.
Consultez les instructions avant de l'utiliser.



Product made with 100% recyclable material.
Prodotto in materiale riciclabile al 100%.
Produit réalisé en matériel 100% recyclable.



Recycling and disposal of electronic waste (WEEE).
Questo prodotto richiede uno smaltimento differenziato (RAEE).
Ce produit nécessite un tri sélectif (DEEE).



Produits ou emballages pouvant faire objet de recyclage.
Visitez le site www.quefairedemesdechets.fr